

# COMPRAG®

positive displacement



CATALOG  
#1

STATIONARY  
Screw Compressors  
**A-series**

## Index

Index	2
Screw Compressors with drive power 7.5-15 kW, capacity up to 2,3 m <sup>3</sup> /min	3
Screw Compressors with drive power 18.5-22 kW, capacity up to 3,6 m <sup>3</sup> /min	8
Screw Compressors with drive power 30-37 kW, capacity up to 5,9 m <sup>3</sup> /min	12
Screw Compressors with drive power 45-55 kW, capacity up to 8,7 m <sup>3</sup> /min	16
Screw Compressors with drive power 75-90 kW, capacity up to 14,3 m <sup>3</sup> /min	20

## Design features of screw compressors



### version (ARD)

built on a horizontal receiver and equipped with a refrigeration dryer

The pressure in the network is kept stable by the air receiver: prevents pulsation in compressed air line when number of appliances is increased; reduces cyclicality in change of operating modes of compressors; reduces wear on air-end, electric motor and drive system; considerable electrical energy efficiency.

The refrigeration dryer removes most of the humidity from the compressed air; prevents water in the compressed air line; extends the service life of the compressed air lines; the compressed air operated devices are protected.

Since all components are already connected, you save installation effort and costs.



### version (AR)

built on a horizontal receiver

The pressure in the network is kept stable by the air receiver: prevents pulsation in compressed air line when number of appliances is increased; reduces cyclicality in change of operating modes of compressors; reduces wear on air-end, electric motor and drive system; considerable electrical energy efficiency.

Since all components are already connected, you save installation effort and costs.



### version (A)

standard version on base frame

Space-saving design.

All other components of the compressed air system can be selected as required.

This Catalogue is valid from 01.02.2021.

All previous catalogues lose their validity with the publication of the new catalogue. Technical characteristics, specifications and details published in this catalogue are subject to change without notice. The latest catalogue version is available for download on our web page [www.comprag.com](http://www.comprag.com)

Comprag GmbH.

Copyright © Comprag GmbH. All rights reserved.

Screw Compressors with drive power 7.5-15 kW, capacity up to 2,3 m<sup>3</sup>/min

A-Series are oil filled screw compressors designed for smooth and economical production of compressed air in industrial plants. They feature a compact, logically laid-out design and are simple to use.



version (ARD)



version (AR)



version (A)

## Features:

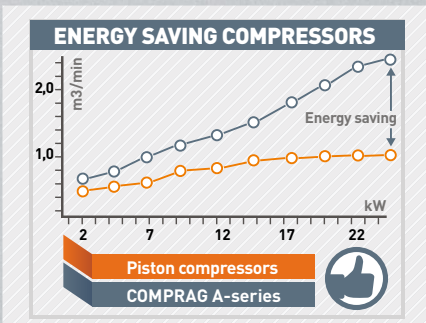

- Modern, energy-efficient air-end.
- Microprocessor controlled for optimal cost-effective compressor operation.
- Through intelligent design of all key components, internal pressure losses are kept to a minimum, resulting in noticeable savings in total energy consumption.
- Through the use of an effective oil separation system, a residual oil content in compressed air of maximum 3 mg/m<sup>3</sup> is attained.
- All filters and separators are easy to reach for economical service.

Screw compressors offer significant energy savings in the 7.5 kW to 22 kW motor power range of compressors when compared to piston compressors. For the same electrical power consumption, the specific cost per cubic meter of compressed air is significantly lower when using A-Series compressors.

## Design and technical characteristics

A-Series screw oil-filled compressors produce industrial compressed air, optionally with refrigerated dryer, up to class 4-4-4 to ISO 8573-1:2010.

New compressor design: Professional controller (A), Reliable electric motor (B), Oil separator tank (C), Screw air-end (D) and Comprag made control valves (E).

**ROTORCOMP**  
VERDICHTER  
INSIDE

### Professional controller t-Log (A)

The controller **t-Log** controls operation of the compressor in automatic mode, and also provides the user with necessary information on the working pressure, temperature of the air oil mixture, compressor operation time, etc.

The professional controller allows a group mode control via several **t-Log** controllers and connection to a higher-level master controller or a control room via MODBUS.

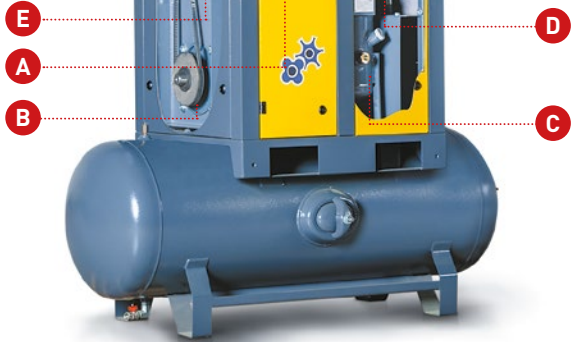

Reliable electric motor (B)

Screw air-end (D)

Control valve (E)

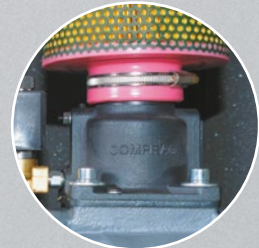

A-Series compressors are fitted with quality electric motors with a high efficiency coefficient and world-class bearings from leading manufacturers.

The motors are not overloaded, but have a power reserve and overheat protection for windings.

The air-end has a contemporary energy-efficient screw shape.

This increases compressor efficiency and reduces maintenance and replacement costs.

Comprag made control valves. Minimum pressure loss, improved unloading time adjustment.

## Flow chart of compressor

- -OIL
- -OIL+AIR
- -AIR

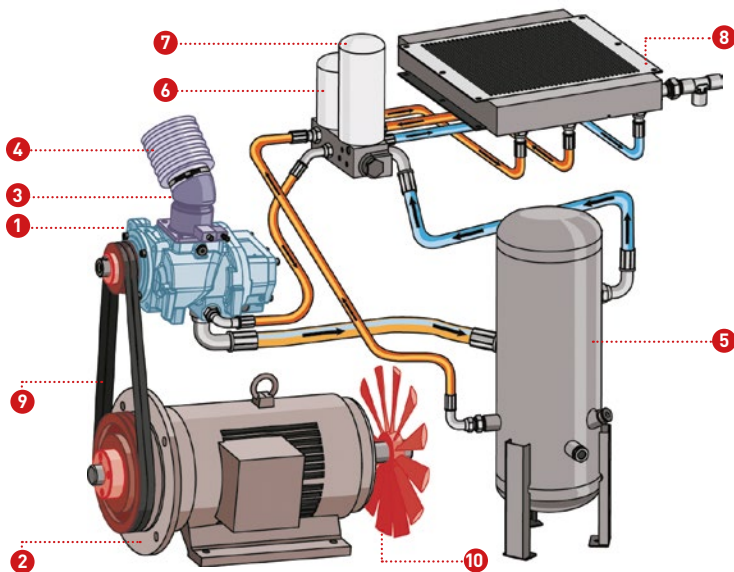

- |                   |                     |                       |                      |                 |
|-------------------|---------------------|-----------------------|----------------------|-----------------|
| 1. Screw air-end  | 3. Air intake valve | 5. Separation vessel  | 7. Spin-On separator | 9. Belt drive   |
| 2. Electric motor | 4. Air filter       | 6. Spin-On oil filter | 8. Heat exchanger    | 10. Cooling fan |

## Table of models A-Series

Article	Model	Drive power (kW)	Max. working pressure (bar)	Capacity* (m <sup>3</sup> /min)	Rated voltage (phase/V/Hz)	Sound pressure level** (dB(A))	Air receiver capacity (liter)	Refrigerated dryer, RDX-Series	Screw connection
11100011	A0708	7,5	8	1,1	3/380-420/50	65	-	-	1/2"
11100012	A0710		10	0,9					
11100013	A0713		13	0,6					
11100015	AR0708-270	7,5	8	1,1	3/380-420/50	65	270	-	1/2"
11100018	AR0708-500						500		
11100016	AR0710-270	7,5	10	0,9	3/380-420/50	65	270	-	1/2"
11100019	AR0710-500						500		
11110011	ARD0708-270	7,5	8	1,1	3/380-420/50	65	270	x	1/2"
11110013	ARD0708-500						500		
11110012	ARD0710-270	7,5	10	0,9	3/380-420/50	65	270	x	1/2"
11110014	ARD0710-500						500		

Article	Model	Drive power (kW)	Max. working pressure (bar)	Capacity* (m³/min)	Rated voltage (phase/V/Hz)	Sound pressure level** (dB(A))	Air receiver capacity (liter)	Refrigerated dryer, RDX-Series	Screw connection
11100021	A1108	11,0	8	1,6	3/380-420/50	67	-	-	1/2"
11100022	A1110		10	1,4					
11100023	A1113		13	1,3					
11100025	AR1108-270	11,0	8	1,6	3/380-420/50	67	270	-	1/2"
11100028	AR1108-500						500		
11100026	AR1110-270	11,0	10	1,4	3/380-420/50	67	270	-	1/2"
11100029	AR1110-500						500		
11110015	ARD1108-270	11,0	8	1,6	3/380-420/50	67	270	x	3/4"
11110017	ARD1108-500						500		
11110016	ARD1110-270	11,0	10	1,4	3/380-420/50	67	270	x	3/4"
11110018	ARD1110-500						500		
11100031	A1508	15,0	8	2,3	3/380-420/50	69	-	-	1/2"
11100032	A1510		10	1,9					
11100033	A1513		13	1,5					
11100035	AR1508-270	15,0	8	2,3	3/380-420/50	69	270	-	1/2"
11100038	AR1508-500						500		
11100036	AR1510-270	15,0	10	1,9	3/380-420/50	69	270	-	1/2"
11100039	AR1510-500						500		
11110019	ARD1508-270	15,0	8	2,3	3/380-420/50	69	270	x	3/4"
11110021	ARD1508-500						500		
11110020	ARD1510-270	15,0	10	1,9	3/380-420/50	69	270	x	3/4"
11110022	ARD1510-500						500		

\* Measured according to ISO 1217; \*\* Measured according to ISO 3744

## Dimensions A-Series

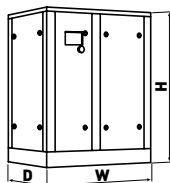

### Dimensions A version

Model	Height H (mm)	Width W (mm)	Depth D (mm)	Weight (kg)
A07	1170	900	700	285
A15	1170	900	700	293
A15	1170	900	700	315

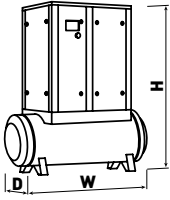

## Dimensions AR / ARD version

Model	Height H (mm)	Width W (mm)	Depth D (mm)	Weight (kg)
AR07..-270/ ARD07.. -270	1650	1470	700	405/440
AR07..-500/ ARD07.. -500	1650	1900	800	447/ 482
AR11..-270/ ARD11.. -270	1650	1470	700	413/450
AR11..-500/ ARD11.. -500	1650	1900	800	455/ 492
AR15..-270/ ARD15.. -270	1650	1470	700	420/460
AR15..-500/ ARD15.. -500	1650	1900	800	462/ 502

Screw Compressors with drive power 18.5-22 kW, capacity up to 3,6 m<sup>3</sup>/min

A-Series are oil filled screw compressors designed for smooth and economical production of compressed air in industrial plants. They feature a compact, logically laid-out design and are simple to use.



version (ARD)



version (AR)



version (A)

## Features:

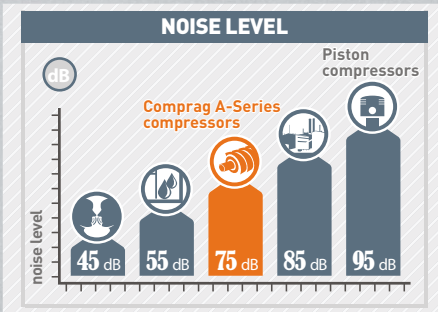

- Modern, energy-efficient air-end.
- Microprocessor controlled for optimal cost-effective compressor operation.
- Through intelligent design of all key components, internal pressure losses are kept to a minimum, resulting in noticeable savings in total energy consumption.
- Through the use of an effective oil separation system, a residual oil content in compressed air of maximum 3 mg/m<sup>3</sup> is attained.
- All filters and separators are easy to reach for economical service.

Comprac A-Series compressors are noise-and vibration-insulated and can be installed in any industrial premises in close proximity to the consumer. This eliminates the need to install costly noise insulation and to run long compressed air lines, thereby reducing pressure losses and increasing system efficiency.



## Design and technical characteristics

A-Series screw oil-filled compressors produce industrial compressed air, optionally with refrigerated dryer, up to class 4-4-4 to ISO 8573-1:2010.

New compressor design: Professional controller (A), Reliable electric motor (B), Oil separator tank (C), Screw air-end (D) and Comprac made control valves (E).



### Professional controller t-Log (A)

The controller **t-Log** controls operation of the compressor in automatic mode, and also provides the user with necessary information on the working pressure, temperature of the air oil mixture, compressor operation time, etc.

The professional controller allows a group mode control via several **t-Log** controllers and connection to a higher-level master controller or a control room via MODBUS.



Reliable electric motor (B)

Screw air-end (D)

Control valve (E)

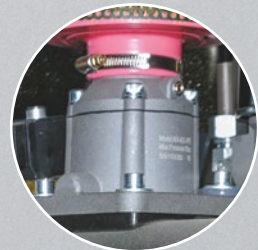

A-Series compressors are fitted with quality electric motors with a high efficiency coefficient and world-class bearings from leading manufacturers.

The motors are not overloaded, but have a power reserve and overheat protection for windings.

The air-end has a contemporary energy-efficient screw shape.

This increases compressor efficiency and reduces maintenance and replacement costs.

Comprac made control valves. Minimum pressure loss, improved unloading time adjustment.

## Flow chart of compressor

- -OIL
- -OIL+AIR
- -AIR

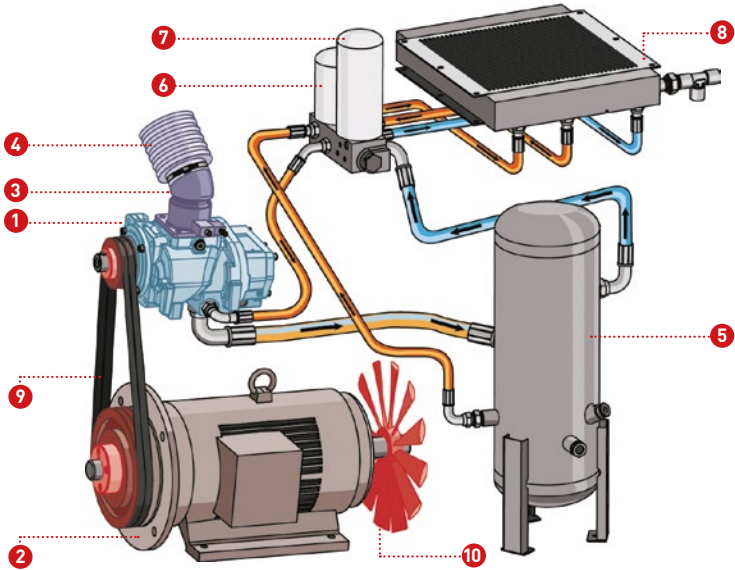

- |                   |                     |                       |                      |                 |
|-------------------|---------------------|-----------------------|----------------------|-----------------|
| 1. Screw air-end  | 3. Air intake valve | 5. Separation vessel  | 7. Spin-On separator | 9. Belt drive   |
| 2. Electric motor | 4. Air filter       | 6. Spin-On oil filter | 8. Heat exchanger    | 10. Cooling fan |

## Table of models A-Series

Article	Model	Drive power (kW)	Max. working pressure (bar)	Capacity* (m <sup>3</sup> /min)	Rated voltage (phase/V/Hz)	Sound pressure level** (dB(A))	Air receiver capacity (liter)	Refrigerated dryer, RDX-Series	Screw connection
11100041	A1808	18,5	8	3,1	3/380-420/50	70	-	-	3/4"
11100042	A1810		10	2,5					
11100043	A1813		13	2,2					
11100045	AR1808-500	18,5	8	3,1	3/380-420/50	70	500	-	3/4"
11100046	AR1810-500		10	2,5					
11110023	ARD1808-500	18,5	8	3,1	3/380-420/50	70	500	x	1"
11110024	ARD1810-500		10	2,5					

Article	Model	Drive power (kW)	Max. working pressure (bar)	Capacity* (m <sup>3</sup> /min)	Rated voltage (phase/V/Hz)	Sound pressure level** dB(A)	Air receiver capacity (liter)	Refrigerated dryer, RDX-Series	Screw connection
11100051	A2208	22,0	8	3,6	3/380-420/50	70	-	-	3/4"
11100052	A2210		10	3,0					
11100053	A2213		13	2,6					
11100055	AR2208-500	22,0	8	3,6	3/380-420/50	70	500	-	3/4"
11100056	AR2210-500		10	3,0					
11110027	ARD2208-500	22,0	8	3,6	3/380-420/50	70	500	x	1"
11110028	ARD2210-500		10	3,0					

\* Measured according to ISO 1217; \*\* Measured according to ISO 3744

## Dimensions A-Series

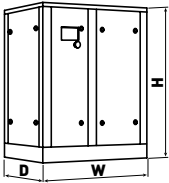

Dimensions A version

Model	Height H (mm)	Width W (mm)	Depth D (mm)	Weight (kg)
A18	1270	1000	800	415
A22	1270	1000	800	435

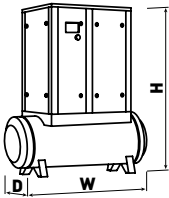

Dimensions AR / ARD version

Model	Height H (mm)	Width W (mm)	Depth D (mm)	Weight (kg)
AR18..-500/ ARD18..-500	1860	1900	800	570/630
AR22..-500/ ARD22..-500	1860	1900	800	590/650

Screw Compressors with drive power 30-37 kW, capacity up to 5,9 m<sup>3</sup>/min

A-Series are oil filled screw compressors designed for smooth and economical production of compressed air in industrial plants. They feature a compact, logically laid-out design and are simple to use.



version (A)

## Features:

A-Series compressors have been developed to offer an optimal balance between performance, energy saving solutions, and offer increased servicing intervals to reduce your running costs. A-Series compressors are most efficient in class.

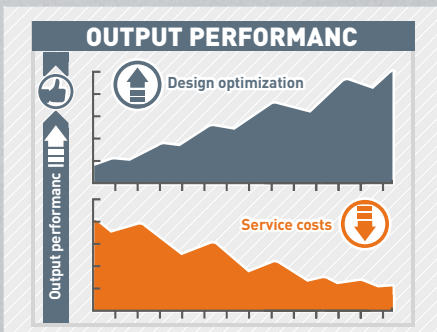

- Modern, energy-efficient air-end.
- Microprocessor controlled for optimal cost-effective compressor operation.
- Through intelligent design of all key components, internal pressure losses are kept to a minimum, resulting in noticeable savings in total energy consumption.
- Through the use of an effective oil separation system, a residual oil content in compressed air of maximum 3 mg/m<sup>3</sup> is attained.
- i-Log controller for more setting and control options a group mode control via several i-Log controllers and connection to a higher-level master controller or a control room via MODBUS.
- All filters and separators are easy to reach for economical service.

## Design and technical characteristics

A-Series screw oil-filled compressors produce industrial compressed air, optionally with refrigerated dryer, up to class 4-4-4 to ISO 8573-1:2010.

New compressor design: Professional controller (A), effective and reliable electric motor (B), screw air-end (C), effective separation system (D).



### Professional controller i-Log (A)

The professional controller **i-Log** controls operation of the compressor in automatic mode, and also provides the user with necessary information on the working pressure, temperature of the air oil mixture, compressor's operation time, need for servicing, etc.

The professional controller allows a group mode control via several **i-Log** controllers and connection to a higher-level master controller or a control room via MODBUS.



Reliable electric motor (B)

Screw air-end (C)

Separation system (D)

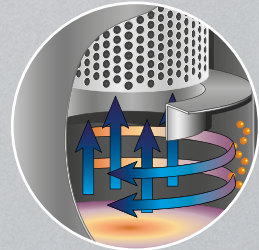

A-Series compressors are fitted with quality electric motors with a high efficiency coefficient and world-class bearings from leading manufacturers.

The motors are not overloaded, but have a power reserve and overheat protection for windings.

The air-end has a contemporary energy-efficient screw shape.

This increases compressor efficiency and reduces maintenance and replacement costs.

A-Series compressors are fitted with an effective three-phase separation system. Most of the oil is separated under centrifugal force in the separator tank. Some of the oil is separated by gravitational force during movement of oil inside the separator.

The remaining amount of oil is separated by a quality separation element. The total amount of oil in compressed air at the outlet of the compressor does not exceed 3 mg/m<sup>3</sup>.

## Flow chart of compressor

- -OIL
- -OIL+AIR
- -AIR

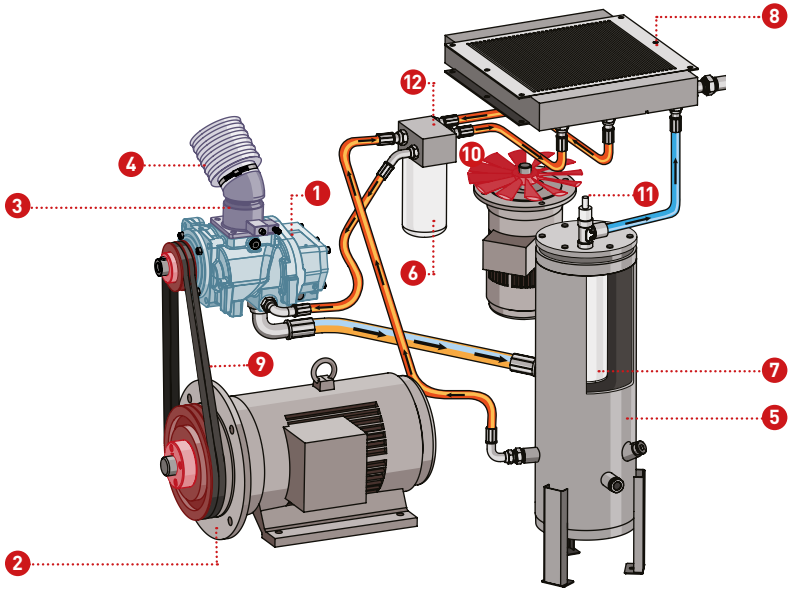

- |                     |                       |                            |
|---------------------|-----------------------|----------------------------|
| 1. Screw air-end    | 5. Separation vessel  | 9. Belt drive              |
| 2. Electric motor   | 6. Spin-On oil filter | 10. Cooling Fan            |
| 3. Air intake valve | 7. Internal separator | 11. Minimum pressure valve |
| 4. Air filter       | 8. Heat exchanger     | 12. Thermostatic valve     |

## Table of models A-Series

Article	Model	Drive power (kW)	Max. working pressure (bar)	Capacity* (m <sup>3</sup> /min)	Rated voltage (phase/V/Hz)	Sound pressure level** (dB(A))	Screw connection
11100061	A3008	30,0	8	4,7	3/380-420/50	72	1.1/4"
11100062	A3010		10	4,0		72	
11100063	A3013		13	3,5		72	
11100071	A3708	37,0	8	5,9	3/380-420/50	72	1.1/4"
11100072	A3710		10	5,1		72	
11100073	A3713		13	4,4		72	

\* Measured according to ISO 1217; \*\* Measured according to ISO 3744

## Dimensions A-Series

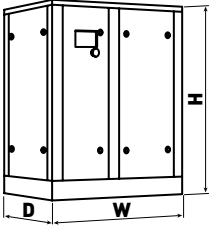

Model	Height H (mm)	Width W (mm)	Depth D (mm)	Weight (kg)
A30	1500	1400	1000	705
A37	1500	1400	1000	745

Screw Compressors with drive power 45-55 kW, capacity up to 8,7 m<sup>3</sup>/min

A-Series are oil filled screw compressors designed for smooth and economical production of compressed air in industrial plants. They feature a compact, logically laid-out design and are simple to use.



version (A)



## Features:

The rotation speed of the helical screw rotor unit is selected on the basis of the specific optimal performance. All compressor components have been designed according to parameters chosen for optimal performance and low operating costs. Comprag A-Series offer some of the lowest specific production costs of compressed air.

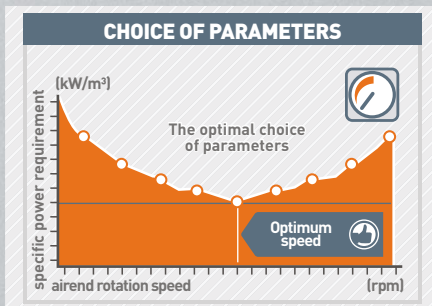

- Modern, energy-efficient air-end.
- Microprocessor controlled for optimal cost-effective compressor operation.
- Through intelligent design of all key components, internal pressure losses are kept to a minimum, resulting in noticeable savings in total energy consumption.
- Through the use of an effective oil separation system, a residual oil content in compressed air of maximum 3 mg/m<sup>3</sup> is attained.
- i-Log controller for more setting and control options a group mode control via several i-Log controllers and connection to a higher-level master controller or a control room via MODBUS.
- All filters and separators are easy to reach for economical service.



## Design and technical characteristics

A-Series screw oil-filled compressors produce industrial compressed air, optionally with refrigerated dryer, up to class 4-4-4 to ISO 8573-1:2010.

New compressor design: Professional controller (A), Effective and reliable electric motor (B), Screw air-end (C), Effective separation system (D).

**ROTORCOMP**  
VERDICHTER  
INSIDE

### Professional controller i-Log (A)

The professional controller **i-Log** controls operation of the compressor in automatic mode, and also provides the user with necessary information on the working pressure, temperature of the air oil mixture, compressor's operation time, need for servicing, etc.

The professional controller allows a group mode control via several **i-Log** controllers and connection to a higher-level master controller or a control room via MODBUS.



Reliable electric motor (B)

Screw air-end (C)

Separation system (D)

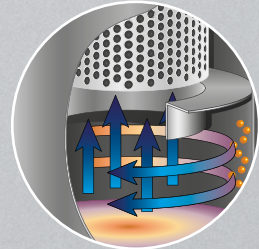

A-Series compressors are fitted with quality electric motors with a high efficiency coefficient and world-class bearings from leading manufacturers.

The motors are not overloaded, but have a power reserve and overheat protection for windings.

The air-end has a contemporary energy-efficient screw shape.

This increases compressor efficiency and reduces maintenance and replacement costs.

A-Series compressors are fitted with an effective three-phase separation system. Most of the oil is separated under centrifugal force in the separator tank. Some of the oil is separated by gravitational force during movement of oil inside the separator.

The remaining amount of oil is separated by a quality separation element. The total amount of oil in compressed air at the outlet of the compressor does not exceed 3 mg/m<sup>3</sup>.

## Flow chart of compressor

- -OIL
- -OIL+AIR
- -AIR

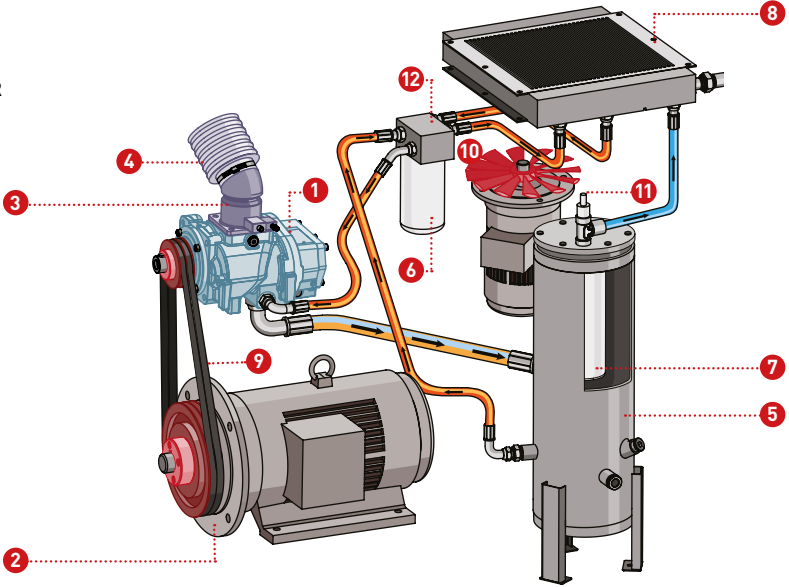

- |                     |                       |                            |
|---------------------|-----------------------|----------------------------|
| 1. Screw air-end    | 5. Separation vessel  | 9. Belt drive              |
| 2. Electric motor   | 6. Spin-On oil filter | 10. Cooling Fan            |
| 3. Air intake valve | 7. Internal separator | 11. Minimum pressure valve |
| 4. Air filter       | 8. Heat exchanger     | 12. Thermostatic valve     |

## Table of models A-Series

Article	Model	Drive power (kW)	Max. working pressure (bar)	Capacity* (m <sup>3</sup> /min)	Rated voltage (phase-V/Hz)	Sound pressure level** dB(A)	Screw connection
11100081	A4508	45,0	8	7,0	3/380-420/50	75	1 1/2"
11100082	A4510		10	6,2		75	
11100083	A4513		13	5,3		75	
11100091	A5508	55,0	8	8,7	3/380-420/50	75	1 1/2"
11100092	A5510		10	7,7		75	
11100093	A5513		13	6,5		75	

\* Measured according to ISO 1217; \*\* Measured according to ISO 3744

## Dimensions A-Series

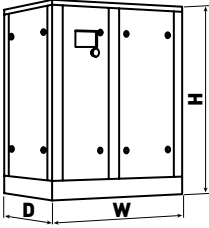

Model	Height H (mm)	Width W (mm)	Depth D (mm)	Weight (kg)
A45	1730	1650	1100	950
A55	1730	1650	1100	1150

Screw Compressors with drive power 75-90 kW, capacity up to 14,3 m<sup>3</sup>/min

A-Series are oil filled screw compressors designed for smooth and economical production of compressed air in industrial plants. They feature a compact, logically laid-out design and are simple to use.



version (A)

## Features:

Up to **94%** of the electric energy expended in driving a compressor may be used again in the form of recuperated heat. A-Series compressors allow heated air to be used efficiently by recovering it for production or storage facilities.

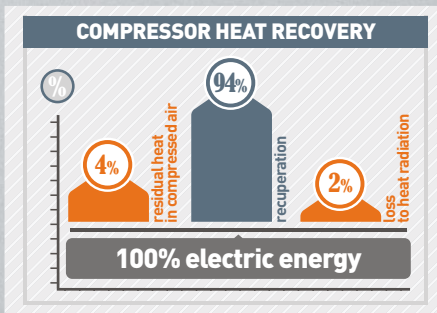

- 100%** - electric energy consumed by compressor
- 4%** - residual heat in compressed air
- 2%** - loss to heat radiation

- Modern, energy-efficient air-end.
- Microprocessor controlled for optimal cost-effective compressor operation.
- Through intelligent design of all key components, internal pressure losses are kept to a minimum, resulting in noticeable savings in total energy consumption.
- Through the use of an effective oil separation system, a residual oil content in compressed air of maximum 3 mg/m<sup>3</sup> is attained.
- i-Log controller for more setting and control options a group mode control via several i-Log controllers and connection to a higher-level master controller or a control room via MODBUS.
- All filters and separators are easy to reach for economical service.

## Design and technical characteristics

A-Series screw oil-filled compressors produce industrial compressed air, optionally with refrigerated dryer, up to class 4-4-4 to ISO 8573-1:2010.

New compressor design: Professional controller (A), Effective and reliable electric motor (B), Screw air-end (C), Effective separation system (D).

**ROTORCOMP**  
VERDICHTER  
INSIDE

### Professional controller i-Log (A)

The professional controller **i-Log** controls operation of the compressor in automatic mode, and also provides the user with necessary information on the working pressure, temperature of the air oil mixture, compressor's operation time, need for servicing, etc.

The professional controller allows a group mode control via several **i-Log** controllers and connection to a higher-level master controller or a control room via MODBUS.



Reliable electric motor (B)

Screw air-end (C)

Separation system (D)

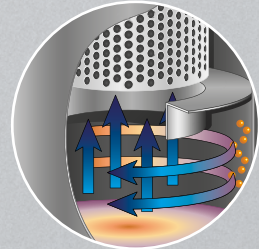

A-Series compressors are fitted with quality electric motors with a high efficiency coefficient and world-class bearings from leading manufacturers.

The motors are not overloaded, but have a power reserve and overheat protection for windings.

The air-end has a contemporary energy-efficient screw shape.

This increases compressor efficiency and reduces maintenance and replacement costs.

A-Series compressors are fitted with an effective three-phase separation system. Most of the oil is separated under centrifugal force in the separator tank. Some of the oil is separated by gravitational force during movement of oil inside the separator.

The remaining amount of oil is separated by a quality separation element. The total amount of oil in compressed air at the outlet of the compressor does not exceed 3 mg/m<sup>3</sup>.

## Flow chart of compressor

- -OIL
- -OIL+AIR
- -AIR

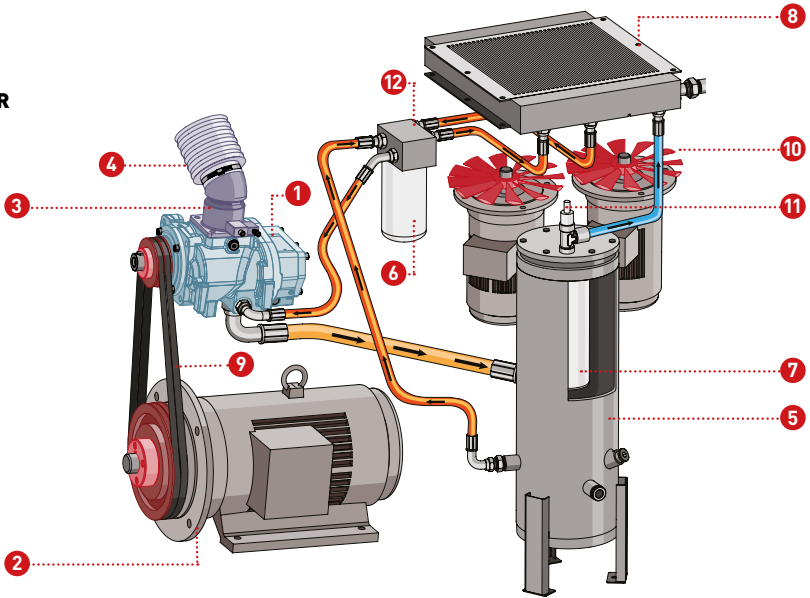

- |                     |                       |                            |
|---------------------|-----------------------|----------------------------|
| 1. Screw air-end    | 5. Separation vessel  | 9. Belt drive              |
| 2. Electric motor   | 6. Spin-On oil filter | 10. Cooling Fan            |
| 3. Air intake valve | 7. Internal separator | 11. Minimum pressure valve |
| 4. Air filter       | 8. Heat exchanger     | 12. Thermostatic valve     |

## Table of models A-Series

Article	Model	Drive power (kW)	Max. working pressure (bar)	Capacity* (m <sup>3</sup> /min)	Rated voltage (phase/V/Hz)	Sound pressure level** (dB(A))	Screw connection
11100101	A7508	75,0	8	11,8	3/380-420/50	75	2"
11100102	A7510		10	10,7		75	
11100103	A7513		13	9,2		75	
11100105	A9008	90,0	8	14,3	3/380-420/50	75	2"
11100106	A9010		10	12,9		75	
11100107	A9013		13	10,9		75	

\* Measured according to ISO 1217; \*\* Measured according to ISO 3744

## Dimensions A-Series

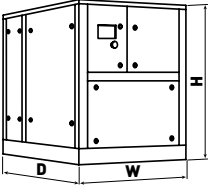

Model	Height H (mm)	Width W (mm)	Depth D (mm)	Weight (kg)
A75	1800	1490	2190	1580
A90	1800	1490	2190	1690



**Comprag GmbH**  
[www.comprag.com](http://www.comprag.com)